

**Port of Kalama – T-Barge Dock**  
**Shoreline Substantial Development and Conditional Use Permit Application**  
March 29, 2018

The project is located at the Port of Kalama, located in the City of Kalama. They have adopted the *1977 Cowlitz County Shorelines Management Master Program (SMMP)*. The narrative below discusses how the proposed project complies with the county's *Shorelines Management Master Program*. Please refer to the application drawings, biological evaluation and critical areas assessment for details on construction, operations, existing conditions, and effects of the project on terrestrial and aquatic habitats and listed species.

**Need for the Dock**

The Port of Kalama is installing a dock to support water-dependent commerce. Currently, a local commercial company serves the shipping industry by delivering ship stores and transporting crew members with small vessels between land and the ships. The small vessels are temporarily moored at the Port of Kalama marina; however, there are not enough slips, so they cannot fully operate their business. Additionally, the Port has determined that their marina will serve recreational, not commercial uses. For these reasons, the Port proposes to provide separate mooring facilities.

Most shipments come from trucks delivering cargo from Seattle to Portland or Astoria and then they are delivered to ships by boat from Portland or Astoria to the ship's location somewhere between Portland and Astoria (102 river miles apart). Boats sometimes pick up cargo in Portland and have to deliver it to Astoria, and vice versa. There is currently no certainty where the cargo will be trucked and where the boat will have to travel from to pick up and deliver their cargo.

By having their truck deliveries and boat operations in Kalama, the tenant will have one definite, central location for truck deliveries between Portland and Astoria. If this project is constructed, truck cargo from Seattle will be delivered to Kalama, saving truck mileage. The Kalama dock and location will also save fuel, river miles, and crew time to deliver cargo to the ships. The following trips are common under existing conditions, and examples of boat distances and running times are as follows: Portland to Kalama is 54 river miles round trip and takes 5 hours, Longview to Kalama is 12 river miles round trip and takes 1 hour, Astoria to Kalama is 150 river miles round trip and takes 8 hours, and Portland to Astoria is 204 river miles round trip and takes 13 hours. It is common for boats to make the trip from Portland to Astoria to pick-up truck deliveries and deliver them to ships.

**Proposed Project**

The T-Barge Dock Project proposed at the Port of Kalama is intended to provide berthing and cargo loading and unloading for three to five commercial boats in the range of 40 to 65 feet long. Their drafts are shallower than the proposed T-barge dock. A pier and gangway will be constructed to provide pedestrian and forklift access from the upland area. Lighting and water utilities will be provided at the dock.

The floating structure is a "T" shaped pontoon that the Port will re-purpose. It is constructed entirely of steel with overall dimensions of about 171 feet by 67 feet with a depth of 12 feet. Its

draft is between 6 and 9 feet, with a freeboard of between 3 and 6 feet. The main section's length is 151 by 20 feet, and the end tee is 67 by 20 feet for a total surface area of 4,360 square feet. Dredging will not be necessary to maintain water depths at this time. The Port has an existing permit for maintenance dredging in this area.

In order to create adequate space for the dock, the adjacent on-water log-storage area will be reduced by 11,000 square feet. This area is smaller than the proposed overwater/on-water impacts, so this project will provide a net gain of 4,601 square feet of unshaded aquatic habitat. Because this project has a net benefit for aquatic habitat, no mitigation plan is required for this project.

There will be no additional barge or ship traffic produced as a result of this project. This project will reduce fuel consumption and will reduce river miles travelled by the delivery boats.

Cowlitz County SMMP designates the subject property as an "urban" environment, and RCW 90.58.030 defines the Columbia River as a "shoreline of statewide significance". Below are the SMMP goals and policies applicable to the project, followed by the applicable regulations. Responses to the SMMP criteria are in *italics* following each criterion, demonstrating the project's consistency with the SMMP goals, policies, and regulations.

# Shoreline Substantial Development Permit Master Program Goals and Policies

## SMMP OVERALL GOALS

The project proposal is consistent with the SMMP local overall goals, which are:

- 1) *Assure healthy, orderly, economic growth in the shorelines of the County.*  
This project helps orderly economic growth by using existing Port property to provide new commercial dock services to ships in the Columbia River.
- 2) *Maintain a high quality environment along the shorelines of Cowlitz County.*  
The project will maintain a high quality environment by avoiding and minimizing impacts from the dock. The project is in an area of existing shoreline development and will not require tree cutting or bank stabilization in functioning riparian areas. The project will also remove 10 orphan piling from the area and will reduce the adjacent log storage area by 11,000 square feet so that there will be fewer impacts to the aquatic habitat than are currently present.
- 3) *Establish criteria for safe, orderly residential growth within the shorelines of Cowlitz County.*  
This project does not involve residential uses.
- 4) *Preserve and protect those fragile and natural resources and culturally significant features along the shorelines of Cowlitz County.*  
This project avoids and minimizes impacts to natural resources while still allowing use of already-developed property. The upland portion of this project is on a filled, gravel area and not on native soils. Cultural features will not be disturbed because the utilities connecting to the dock will be trenched in existing fill material.
- 5) *Provide safe and reasonable access for the public in the shorelines of Cowlitz County.*  
There are no plans to change the existing public access to the shorelines.
- 6) *Preserve the rights of private ownership and property uses of the shorelines of Cowlitz County.*  
This project maintains private ownership rights and property uses.

## APPLICABLE SPECIFIC GOALS AND POLICIES FOR AREAS

Areas considered by the master program include circulation, conservation, economic development, historical/cultural, recreation, residential, public access, and other general shoreline uses. Only the areas that apply to this project are addressed below.

### Conservation

Goal: *“To encourage best management practices for the continued sustained yield or replenishable resources of the shorelines and preserve, protect, and restore those unique and non-renewable resources.”*

Objectives:

- 1) *Preserve the scenic and aesthetic qualities of shorelines and vistas.*

This project was designed to be only as large as necessary to meet the project purpose. The project vicinity has similar and larger dock facilities and shoreline uses, so this project preserves existing scenic and aesthetic qualities of the shoreline and vistas.

- 2) *Contribute (as far as the state of the art allows) to a maximum utilization of the resources without harming other natural systems of the quality of life.*

This project is consistent with this goal and its objectives by avoiding and minimizing unavoidable impacts to aquatic and terrestrial habitat. No degradation of the bank or shoreline areas will occur because the project is being constructed in an area that already has few riparian functions.

- 3) *Restore damaged features of ecosystems to a higher quality than may currently exist.*

In order to create adequate space for the dock, the adjacent on-water log-storage area will be reduced by 11,000 square feet. This area is smaller than the proposed overwater/on-water impacts, so this project will provide a net gain of 4,601 square feet of unshaded aquatic habitat. The project will also remove 10 orphan piling from the area and reduce the adjacent log storage area so there will be an overall gain in aquatic habitat quality than is currently present.

- 4) *Preserve unique and non-renewable resources.*

The site does not contain any unique or non-renewable resources.

- 5) *Consider the total upstream and downstream effect of proposed developments to ensure that no degradation will occur to the shoreline area.*

The project has been designed by a licensed engineer to have no significant effects on river hydraulics or the shoreline.

### Economic Development

Goal: *To encourage the establishment and development of industrial and commercial activities in Cowlitz County on shorelines that require the land-water interface for productive efforts.*

Objective: *“Those economic developments proposed on the shorelines must effectively operate without reducing the environmental quality of the surrounding and adjacent shoreline area, or the quality of life of county residents.*

Policies 1 through 4 and 7 under this objective do not apply to this project. The Policies 5 and 6 are addressed below.

## **5. Ports and Water-Related Industry**

*Items a) through e) and h) do not apply to this project.*

*f) Because industrial docks and piers are often longer and greater in bulk than recreational or residential piers, careful planning must be undertaken to reduce the adverse impact of such facilities on other water-dependent uses, aesthetics, and shoreline resources. Because heavy industrial activities are associated with industrial piers and docks, the location of these facilities must be considered a major factor in determining the environmental and aesthetic compatibility of such facilities.*

The project vicinity has similar and larger dock facilities and shoreline uses, so this project preserves existing scenic and aesthetic qualities of the shoreline and vistas. There are industrial docks on the adjacent parcel, so the general view of nearshore areas from the river will not change appreciably.

*g) Because a large impact cannot be avoided due to ports and port-related uses, preference will be given to development and redevelopment of existing port areas.*

This location is within the Port of Kalama, so this requirement is met.

## **6. Utilities**

*a) Upon completion of installation/maintenance projects on shorelines, banks should be restored to pre-project configuration, replanted with native species, and provided maintenance care until the newly planted vegetation is established.*

The utility line for this project will be underground along the existing roadway. There are no plans to restore native plantings in the upland area where no vegetation currently exists because the area will be used by forklifts to load and unload boats using the dock.

*b) Whenever these facilities must be placed in a shoreline area, the location should be chosen so as not to obstruct or destroy scenic views. Whenever feasible, these facilities should be placed underground, or designed to do minimal damage to the aesthetic qualities of the shoreline area.*

The utility line will be placed underground, so it will not obstruct views.

*c) To the extent feasible, local government should attempt to incorporate major transmission line rights-of-way on shorelines into their program for public access to, and along, waterbodies.*

There are no major transmission lines proposed as part of this project.

- d) *Utilities should be located to meet the needs of future populations in areas planned to accommodate this growth.*

The new utility line will only serve this parcel.

## **Historical/Cultural**

*Goal: “Protect, preserve, and restore those historical, cultural, educational, and scientific sites in the shorelines of Cowlitz County for the general public.”*

The project site has already undergone fill activities, and there are no proposed activities in upland areas that would extend below the filled profile. A cultural resources assessment report concluded that there are not likely cultural or historical resources in the project area. This report is included in the application package. Therefore, no historical, cultural, educational, or scientific sites are likely to be disturbed by this project. The proposed project meets this goal.

## **Public Access**

*Goal: To assure the safe and reasonable access, for the public, to public property in the shorelines of Cowlitz County.*

Objectives:

- 1) *To retain existing public access and develop additional access where such will not endanger life or property nor interfere with the rights inherent with private property.*

This parcel does not provide public access other than allow access to the public walkway on the shoreline. There are no plans to block this walkway or to allow the public on this commercial dock, so public access will not change as a result of this project. Therefore, the adjacent public access of the boardwalk and public marina will be maintained and will not be impacted.

- 2) *Such access should not have an adverse effect on unique or fragile natural features, nor alter ecological systems of the area.*

There are no proposed changes to public access to the shoreline.

- 3) *Future roads, when built paralleling shorelines, shall provide multiple-point access to the shoreline wherever possible to ease concentration.*

No roads are proposed for this project, so this objective does not apply.

## **Other General Shoreline Uses**

*Goal: Development within the shorelines of Cowlitz County must be for the betterment of the lifestyle of the citizens of Cowlitz County, and so located as to prevent ecological debilitation from occurring.*

Policies 1, 2, 3, 5, and 6 (dredging, landfill, shoreline protection works, restoration, and solid waste disposal) are not proposed by this project and will not be addressed in this narrative. Policy 4 is addressed below:

### **Piers**

- a) *The use of floating docks should be encouraged in those areas where scenic values are high and where conflicts with recreational boaters and fishermen will not be created.*

The proposed structure is a floating dock near the shoreline in an area already used for commercial purposes. The proposed location maintains recreational boat access to the existing marina.

- b) *Open-pile piers should be encouraged where shore trolling is important, where there is significant littoral drift, and where scenic values will not be impaired.*

An open-pile pier is proposed, but trolling does not occur this close to the shoreline in the project area.

- c) *Priority should be given to the use of community piers and docks in all new major waterfront developments. In general, encouragement should be given to the cooperative use of piers and docks.*

The proposed dock is for commercial use, so this policy is not applicable.

- d) *In providing for boat docking facilities in the master program, local governments should consider the capacity of the shoreline sites to absorb the impact of waste discharges from boats, including gas and oil spillage.*

This service operation is currently operational on the river, so these impacts are already occurring. This project will reduce the number of river miles traveled by the service boats, and it will also reduce truck traffic on the highways to deliver cargo to the new dock. Truck traffic creates stormwater pollution, which will be minimized by reducing truck traffic, so overall water quality will improve when compared to current conditions.

- e) *The risk and potential damage of contaminants must be determined for piers and the ability of the shoreline area to recover from such spills must be known. Where appropriate, contamination prevention and abatement measures will be required as part of any proposal to erect a pier.*

Supplies that will be transferred to and from boats using the proposed dock generally do not contain contaminants. Best management practices will avoid and minimize potential contaminants released to the river during construction.

## **USE ACTIVITY REGULATIONS**

The following use activity regulations are applicable to the proposed project: Conditional Uses, Construction and Operations Regulations, Ports and Water-Related Industries, and Utilities.

## Conditional Uses

Conditional uses are those uses which either do not need a shoreline location or are considered unsuitable for siting within a particular shoreline environment. Uses classified as subject to the issuance of a Conditional Use Permit can be permitted only by meeting such performance standards that make the use compatible with other permitted uses within that area. Conditional Use Permits shall be granted only after the applicant can demonstrate all of the following:

- 1) *The use will cause no unreasonable adverse effects on the environment or other uses within the area.*

The project is designed to avoid unreasonable adverse effects on the environment as described above, and it will not affect other uses in the area because there are similar uses on adjacent parcels.

- 2) *The use will not interfere with the public use of public shorelines.*

As discussed above, this project will not change public uses in the project vicinity.

- 3) *The design of the proposed use will be compatible with the environment in which it will be located.*

As discussed above, this project is compatible with uses on adjacent properties.

- a) *Specific performance standards shall be imposed and/or developed for any given use to make that use compatible to the natural or conservancy environments in which that use will locate.*

This project is in the Urban District, so this item does not apply.

- 4) *The proposed use will not be contrary to the goals, policy statements, or general intent of the shoreline environments of this master program.*

As discussed throughout this document, this project meets the goals, policy statements and general intent of the master program.

## Construction and Operations Regulations

The following regulations cover the construction practices that must be observed for substantial developments.

- 1) *No construction equipment shall enter any shoreline body of water, except as authorized under the terms of a substantial development permit.*

This regulation will be followed.

- 2) *Vegetation along the water shall be left in its natural condition unless the substantial development permit allows otherwise.*

There is no existing native vegetation beneath the area proposed for the pier.

- 3) *During construction, care will be taken to assure that waste material and foreign matter are not allowed to enter the water.*



This regulation will be followed.

- 4) *All fuel and chemicals shall be kept, stored, handled, and used in a fashion which assures that there will be no opportunity for entry of such fuel and chemicals into the water.*

This regulation will be followed.

- 5) *Protection from siltation and erosion shall be provided for on all earthworks projects.*

This project does not propose earthworks.

- 6) *Land being prepared for development shall have an adequate drainage system to prevent runoff from entering waterbodies.*

There is no proposed upland development. The existing graveled area will be maintained, and existing stormwater flow directions away from the river will be maintained. Therefore, the existing drainage will not be affected.

- 7) *Side casting of excess road-building material into streams will not be permitted.*

This project does not propose road building.

- 8) *All construction debris such as fuel and oil containers and barrels and other miscellaneous litter shall be removed from the shoreline area. No equipment shall be abandoned within the shoreline area.*

This regulation will be followed.

- 9) *State and federal water quality standards for both interstate and intrastate waters already are established. These shorelines regulations need only allude to these and other regulations already in effect. Any activities within the shorelines must, as a minimum, meet all these other regulations.*

All terms and conditions of every state, local, and federal permit will be followed to protect water quality.

## **Ports and Water-Related Industries**

The following regulations are listed for the Urban District.

- 1) *Port facilities and water-related industries shall be permitted on urban shorelines.*

This regulation does not require a response from the applicant. This project is a permitted use.

- 2) *Any person proposing a development, expansion, or alteration, or any phase thereof which constitutes a complete project, of a port facility or water-related industry, shall apply for a permit.*

The applicant is applying for permits.

3) *A permit for a port facility or water-related industry, or any expansion or alteration thereof which constitutes a complete project, may be granted a permit subject to compliance with local ordinances and the following regulations:*

a) *Demonstration of compliance with the regulations specified on any federal and state permits required for such facilities and operations, by presentation of an application for each permit or other means satisfactory to the administrator.*

Copies of applications for other permits are provided as part of the application package.

b) *Compliance with other applicable use regulations in this program is required.*

The project will comply with all applicable use regulations as discussed in this application.

Use regulations 4 and 5 do not apply to this project, because the project does not propose additional log storage areas.

## **Utilities**

The following regulations are listed for the Urban District.

1) *Regulations Nos. 2 and 3 under the conservancy district shall apply to urban shorelines.*

*Conservancy District Regulation 2: Any person proposing to install or construct a utility system shall apply for a permit.*

The applicant is applying for a permit.

*Conservancy District Regulation 3: A permit shall be granted subject to the following regulations:*

a) *All such utility systems shall be underground unless such undergrounding would not be feasible.*

The applicant proposes underground utilities.

b) *Where such utility systems occupy shoreline areas, clearing necessary for installation or maintenance shall be kept to the minimum width necessary to prevent interference by trees and other vegetation with the proposed transmission facilities.*

No clearing is necessary, because there is no vegetation in the proposed utility corridor.

c) *Upon completion of installation of such utility systems or of any maintenance project which disrupts the environment, the disturbed area shall be regraded to compatibility with the natural terrain and replanted to prevent erosion and provide an attractive, harmonious vegetation cover.*

There is no existing vegetation in the proposed utility corridor.

- 2) *Utility hookup linkages to shoreline-use activities shall be underground where feasible.*  
The applicant proposes underground utilities.

## Cowlitz County Shoreline Conditional Use Supplement – P.3.4

**Applicant/Property Owner:** Port of Kalama

**Project Address:** Directly across from 380 West Marine Drive in Kalama, Washington

1) *Describe the project and the reason for the conditional use request.*

The project's need and purpose, as well as the project description, are described on page 1 of this document. A conditional use permit is necessary because the project includes installing a new dock, pier, and gangway.

2) *Will the proposed use:*

a. *Recognize and protect statewide interest over local interest?*

The project promotes the statewide interest by proposing a commercial dock to be located separately from the marina, which is for recreational boat moorage. As set forth in the Shoreline Management Act, preference and priority is given to industrial and commercial developments which are particularly dependent on shoreline location or use (RCW 90.58.020). The proposed site use is to transport a stable supply of cargo for use by the shipping industry, which promotes the economy by supporting an on-going water-dependent use that provides employment opportunities, a source of tax revenue, and contributes to the economic health of the state along a Shoreline of Statewide Significance. The project furthers these state interests in maintaining and sustaining commercial use of the Columbia River.

b. *Preserve the natural character of the shoreline?*

The project will avoid and minimize impacts from the dock. The project is in an area of existing shoreline development and will not require tree cutting or bank stabilization in functioning riparian areas. The project will also remove 10 orphan piling from the area and reduce the adjacent log storage area so that there will be fewer impacts to the aquatic habitat than are currently present.

c. *Result in long-term over short-term benefit?*

The proposed commercial dock is expected to be used over the long term. Benefits include reducing truck traffic to current delivery locations in Portland and Astoria, as well as providing moorage in a central location that will reduce the number of river miles traveled. Benefits also include reducing on-water log storage for the adjacent mill.

d. *Protect the resources and ecology of the shoreline?*

The project will avoid and minimize impacts from the dock. The project is in an area of existing shoreline development and will not require tree cutting or bank stabilization in functioning riparian areas. The project will also remove 10 orphan piling from the area

and reduce the adjacent log storage area so that there will be fewer impacts to the aquatic habitat than are currently present.

e. *Increase public access to publicly owned areas of the shoreline.*

There are no plans to change existing public access to the shorelines. The project site small, it is near the Port's marina and park that have numerous points of access to the shorelines, and it will not block existing public access.

f. *Increase recreational opportunities for the public in the shorelines.*

There are no plans to change existing public recreational opportunities on the shorelines, because numerous opportunities already exist adjacent to the project site. The project site small, it will not block existing public access, and it is near the Port's marina and park that have several points of access to the shorelines.

3) *Will the proposed use interfere with the normal public use of public shorelines?*

There are no plans to change existing public access to the shorelines, and the project will not block existing public use.

4) *Will the proposed use cause adverse effects to the shoreline environment designation in which it is to be located?*

The proposed project is in the Urban District, precisely where water-dependent, commercial facilities are intended to be located.

5) *Will the public interest suffer a detrimental effect as a result of your project?*

The public interest will be positively affected by promoting long-term and stable economic development as a result of the project. This project will support the shipping industry, is water-dependent, and will promote the public welfare while also protecting public access and the aquatic environment to the maximum extent practicable. The project will improve aquatic habitat by removing larger areas of on-water log storage and orphan piles than the proposed dock, pier, and gangway. There will be no detrimental effects to the public interest.

4/2/2018 3:12 PM \\ECOSERVER2\Company\ELSIWA\CowlitzKalama\2367.pnd engineers\2367.04-pok barge dock\2367.04-figures\2367.04\_BA.dwg Jack

WASHINGTON



SITE

46.0097° Latitude  
-122.8484° Longitude

LOCATION MAP

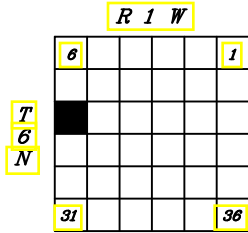

**NOTE:**  
USGS topographic quadrangle map reproduced using  
MAPTECH Inc., Terrain Navigator Pro software.

PROJECT VICINITY MAP

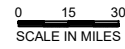
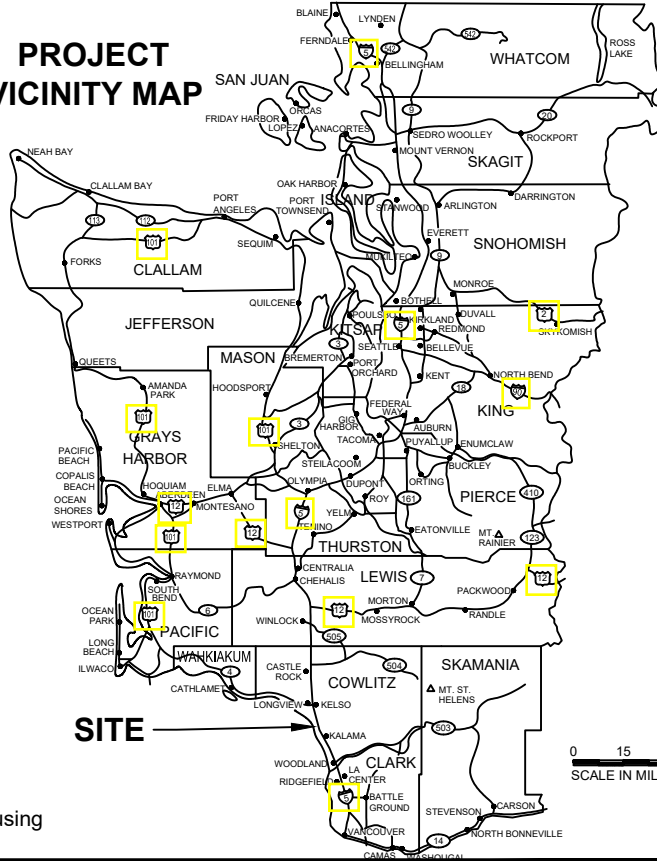

**PROPOSED:** New Dock

**IN** Columbia River - RM 74.3

**NEAR:** Kalama

**COUNTY:** Cowlitz **STATE:** WA

**SHEET 1 OF 8**

**DATE:** 4/2/18

**VICINITY MAP**

**APPLICANT:** Port of Kalama

**PROJECT NAME:** Port of Kalama T-Barge Dock

**REFERENCE #:** Not Yet Assigned

**SITE LOCATION ADDRESS:**  
1296 Third St. NW  
Kalama, WA

**PURPOSE:**

Moor small vessels to  
serve shipping industry

**DATUM:** NAD83

**ADJACENT PROPERTY OWNERS:**

Sec JARPA

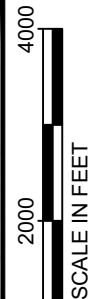

1157 3rd Ave., Suite 220A  
Longview, WA 98632  
Phone: (360) 578-1371

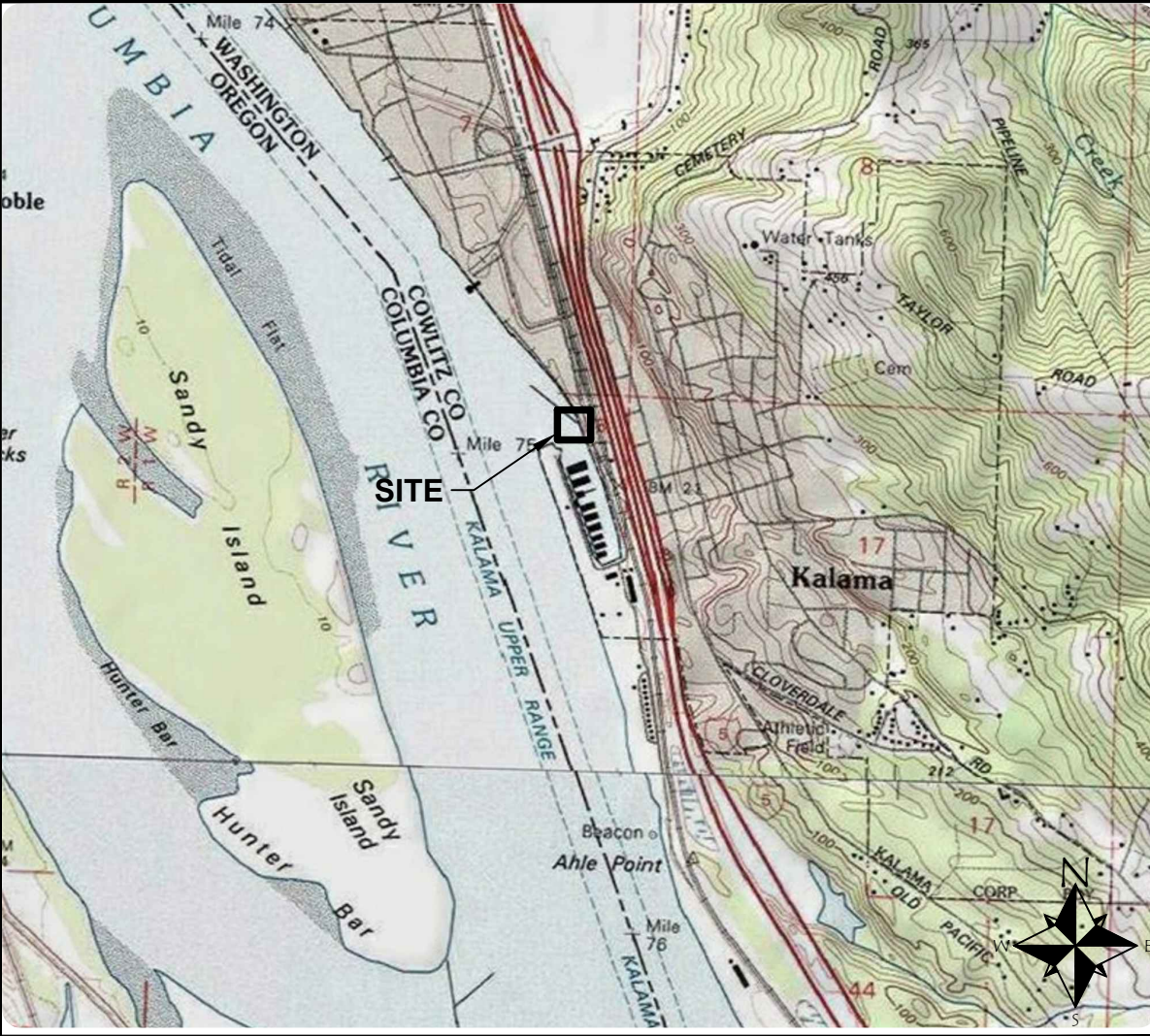

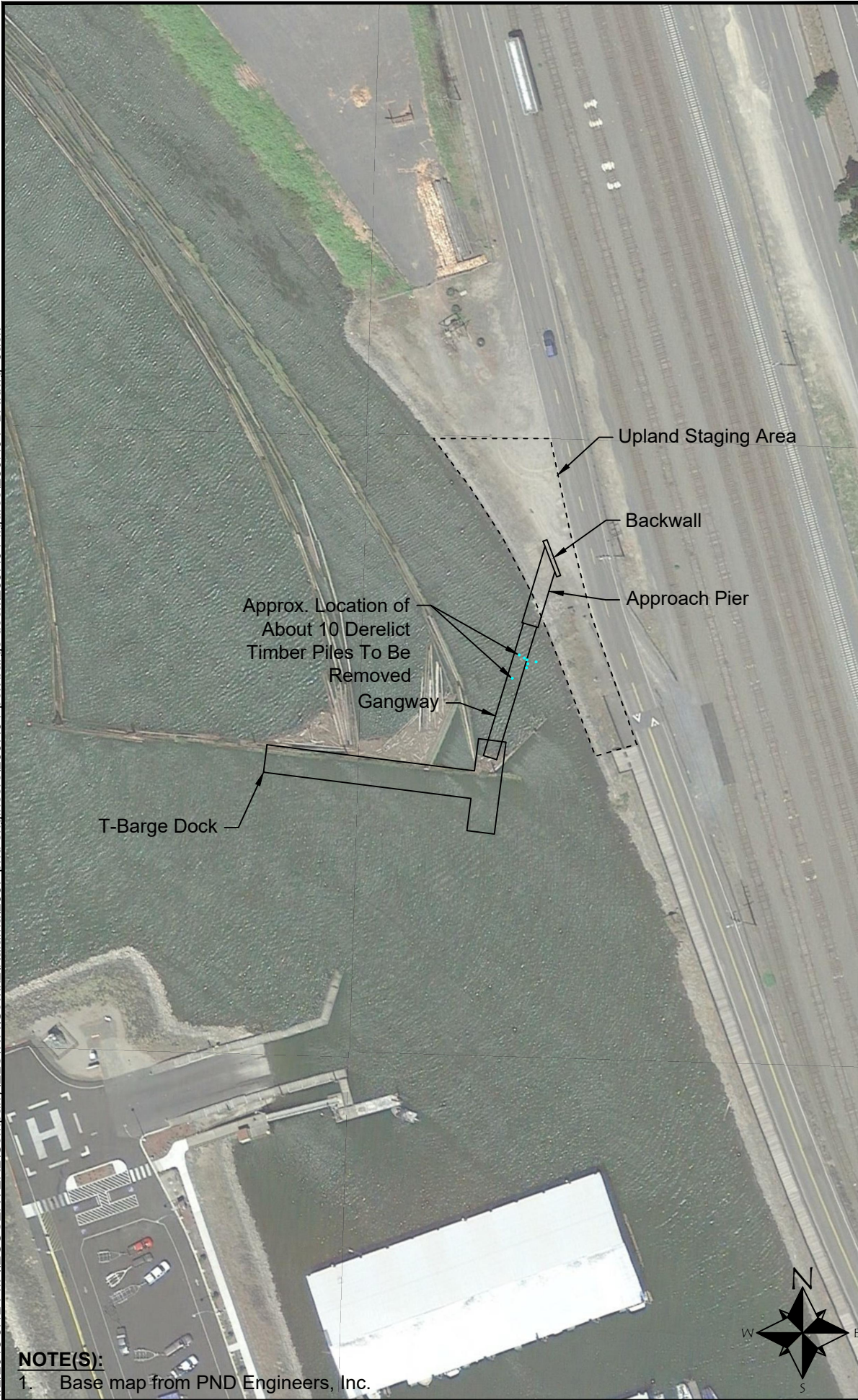

**PROPOSED:** New Dock  
**IN** Columbia River - RM 74.3  
**NEAR:** Kalama  
**COUNTY:** Cowlitz    **STATE:** WA  
**SHEET 2 OF 8**  
**DATE:** 4/2/18

**AERIAL PHOTOGRAPH**  
**APPLICANT:** Port of Kalama  
**PROJECT NAME:** Port of Kalama T-Barge Dock  
**REFERENCE #:** Not Yet Assigned  
**SITE LOCATION ADDRESS:**  
1296 Third St. NW  
Kalama, WA

**PURPOSE:**  
Moored small vessels to serve shipping industry  
**DATUM:** NAD83  
**ADJACENT PROPERTY OWNERS:**  
See JARPA

0 100 200  
SCALE IN FEET

1157 3rd Ave., Suite 220A  
Longview, WA 98632  
Phone: (360) 578-1371



**Ecological Land Services**

**NOTE(S):**

- 1. Base map from PND Engineers, Inc.

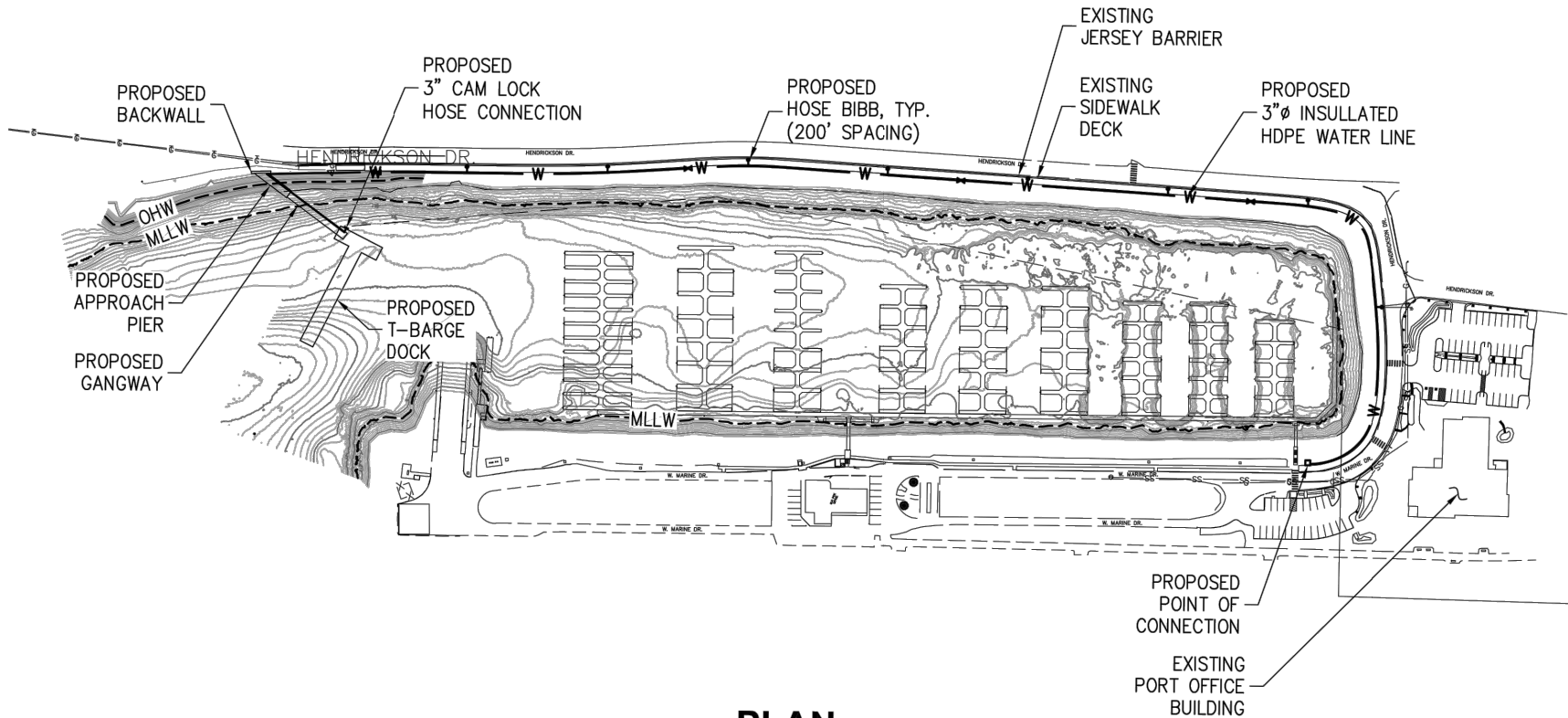

**PLAN**

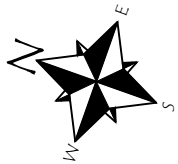

**NOTE(S):**

1. Base map from PND Engineers, Inc.



1157 3rd Ave., Suite 220A  
 Longview, WA 98632  
 Phone: (360) 578-1371

|   |   |  |
|---|---|--|
| <p><b>PURPOSE:</b><br/>Moor small vessels to serve shipping industry</p> <p><b>DATUM:</b> NAD83</p> <p><b>ADJACENT PROPERTY OWNERS:</b><br/>See JARPA</p> | <p><b>OVERALL SITE PLAN</b></p> <p><b>APPLICANT:</b> Port of Kalama</p> <p><b>PROJECT NAME:</b> Port of Kalama T-Barge Dock</p> <p><b>REFERENCE #:</b> Not Yet Assigned</p> <p><b>SITE LOCATION ADDRESS:</b><br/>1296 Third St. NW<br/>Kalama, WA</p> | <p><b>PROPOSED:</b> New Dock</p> <p><b>IN</b> Columbia River - RM 74.3</p> <p><b>NEAR:</b> Kalama</p> <p><b>COUNTY:</b> Cowlitz <b>STATE:</b> WA</p> <p><b>SHEET 3 OF 8</b></p> <p><b>DATE:</b> 4/2/18</p> |
|---|---|--|



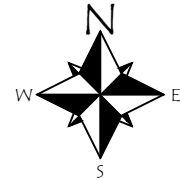
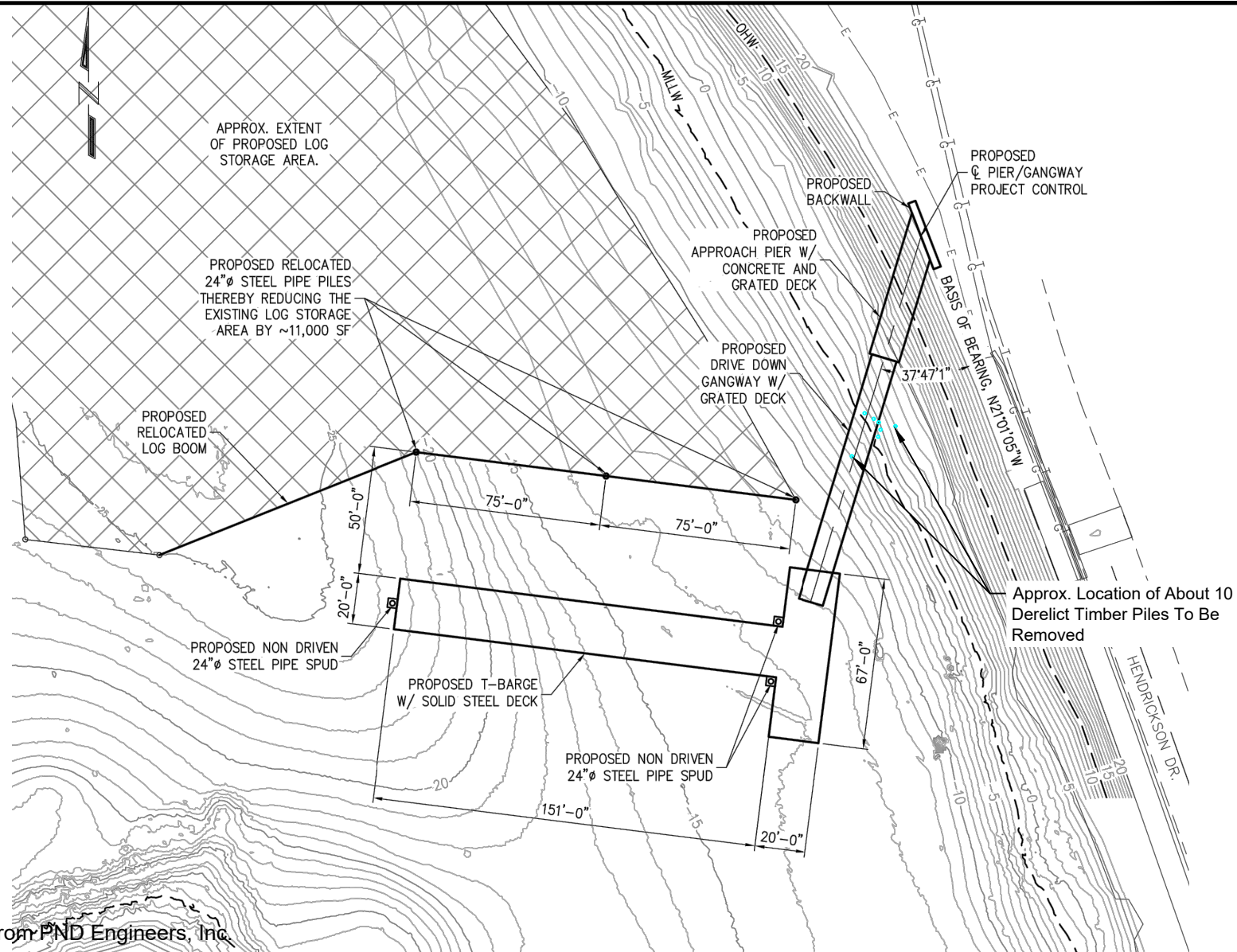

**NOTE(S):**  
 1. Base map from PND Engineers, Inc.



1157 3rd Ave., Suite 220A  
 Longview, WA 98632  
 Phone: (360) 578-1371

|   |   |  |
|---|---|--|
| <p><b>PURPOSE:</b><br/>Moor small vessels to serve shipping industry</p> <p><b>DATUM:</b> NAD83</p> <p><b>ADJACENT PROPERTY OWNERS:</b><br/>See JARPA</p> | <p align="center"><b>PROPOSED SITE PLAN</b></p> <p><b>APPLICANT:</b> Port of Kalama</p> <p><b>PROJECT NAME:</b> Port of Kalama T-Barge Dock</p> <p><b>REFERENCE #:</b> Not Yet Assigned</p> <p><b>SITE LOCATION ADDRESS:</b><br/>1296 Third St. NW<br/>Kalama, WA</p> | <p><b>PROPOSED:</b> New Dock</p> <p><b>IN</b> Columbia River - RM 74.3</p> <p><b>NEAR:</b> Kalama</p> <p><b>COUNTY:</b> Cowlitz <b>STATE:</b> WA</p> <p><b>SHEET 4 OF 8</b></p> <p><b>DATE:</b> 4/2/18</p> |
|---|---|--|

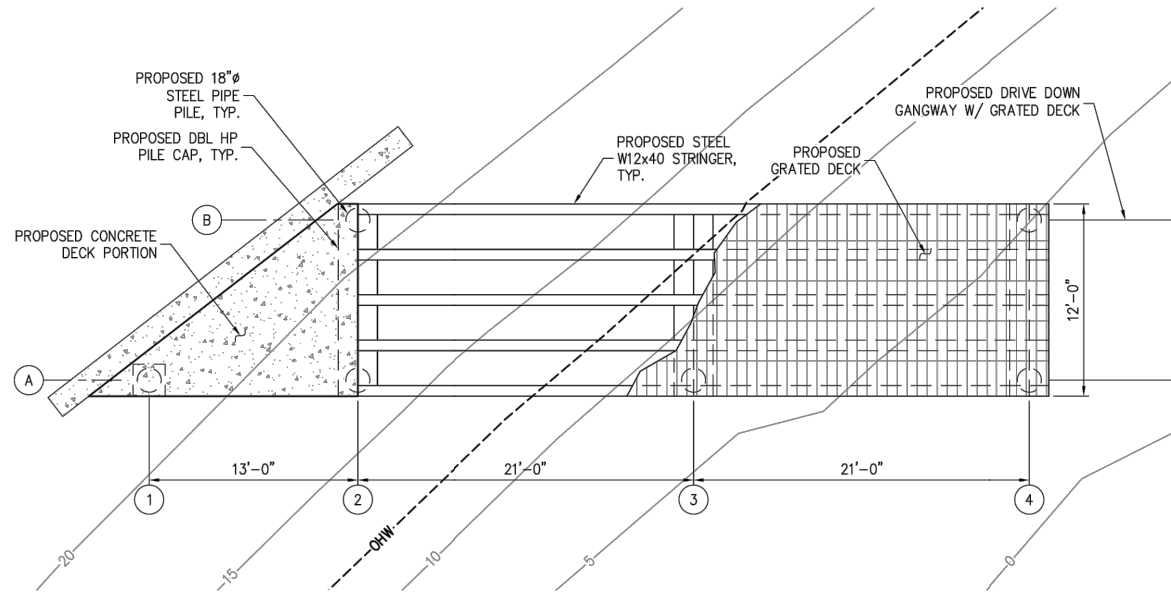

**APPROACH PIER PLAN**

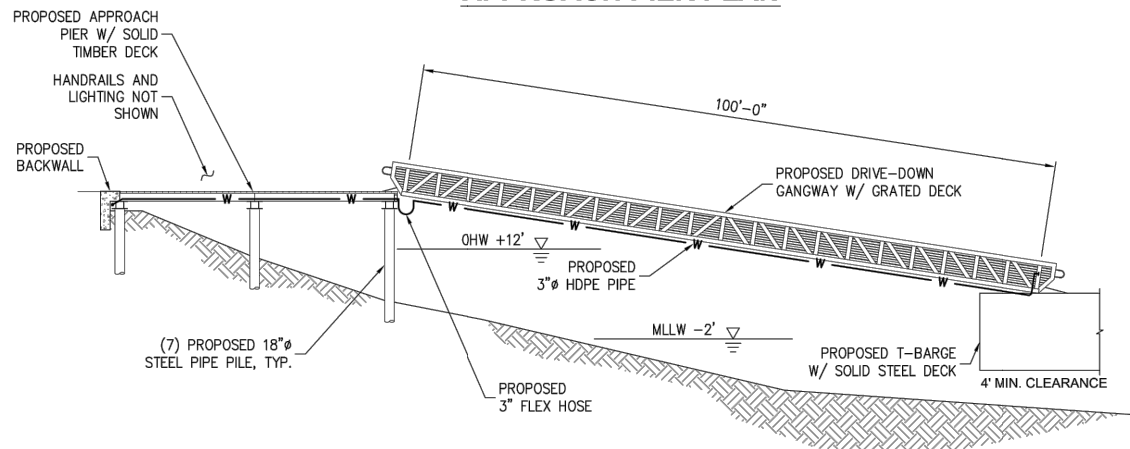

**GANGWAY SECTION**

**NOTE(S):**

1. Functional grating will be at least 25%.



1157 3rd Ave., Suite 220A  
Longview, WA 98632  
Phone: (360) 578-1371

|   |  |   |
|---|--|---|
| <p><b>PURPOSE:</b><br/>Moor small vessels to serve shipping industry<br/><b>DATUM:</b> NAD83<br/><b>ADJACENT PROPERTY OWNERS:</b><br/>See JARPA</p> | <p><b>APPROACH PIER PLAN &amp; GANGWAY SECTION</b><br/><b>APPLICANT:</b> Port of Kalama<br/><b>PROJECT NAME:</b> Port of Kalama T-Barge Dock<br/><b>REFERENCE #:</b> Not Yet Assigned<br/><b>SITE LOCATION ADDRESS:</b><br/>1296 Third St. NW<br/>Kalama, WA</p> | <p><b>PROPOSED:</b> New Dock<br/><b>IN</b> Columbia River - RM 74.3<br/><b>NEAR:</b> Kalama<br/><b>COUNTY:</b> Cowlitz <b>STATE:</b> WA<br/><b>SHEET 5 OF 8</b><br/><b>DATE:</b> 4/2/18</p> |
|---|--|---|



Looking from the north to the east at the proposed project site. The three circled piles will be relocated to the north and the bank protection will remain as shown.

NOT TO SCALE



1157 3rd Ave., Suite 220A  
 Longview, WA 98632  
 Phone: (360) 578-1371

|   |  |  |
|---|--|--|
| <p><b>PURPOSE:</b><br/>                 Moor small vessels to serve shipping industry<br/> <b>DATUM:</b> NAD83<br/> <b>ADJACENT PROPERTY OWNERS:</b><br/>                 See JARPA</p> | <p style="text-align: center;"><b>PHOTOPLATE 1</b></p> <p><b>APPLICANT:</b> Port of Kalama<br/> <b>PROJECT NAME:</b> Port of Kalama T-Barge Dock<br/> <b>REFERENCE #:</b> Not Yet Assigned<br/> <b>SITE LOCATION ADDRESS:</b><br/>                 1296 Third St. NW<br/>                 Kalama, WA</p> | <p><b>PROPOSED:</b> New Dock<br/> <b>IN</b> Columbia River - RM 74.3<br/> <b>NEAR:</b> Kalama<br/> <b>COUNTY:</b> Cowlitz <b>STATE:</b> WA<br/> <b>SHEET 6 OF 8</b><br/> <b>DATE:</b> 4/2/18</p> |
|---|--|--|

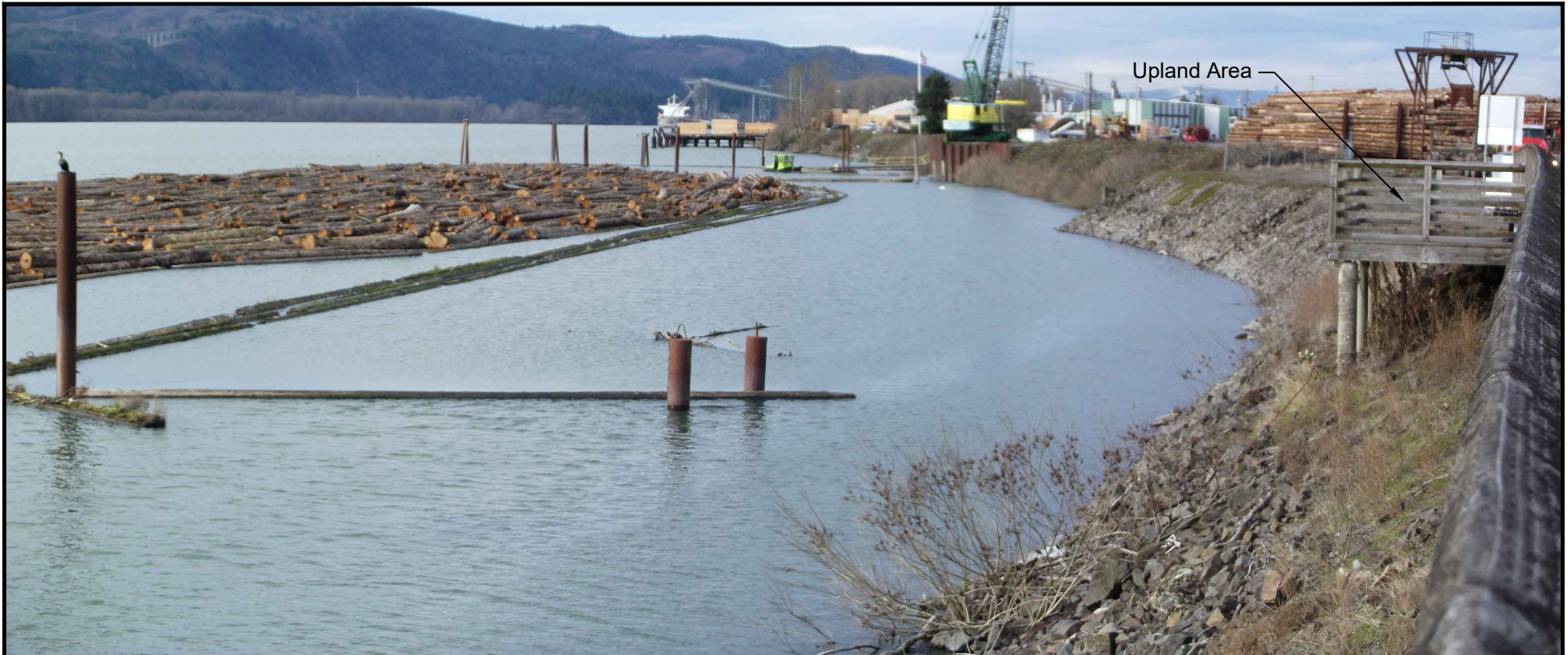

Looking at the existing log storage area and shoreline conditions. The proposed upland area is on the right side of the photograph. Pile caps will be installed on all new and relocated piling to prevent bird perching.

NOT TO SCALE



1157 3rd Ave., Suite 220A  
Longview, WA 98632  
Phone: (360) 578-1371

**PURPOSE:**

Moor small vessels to serve shipping industry

**DATUM:** NAD83

**ADJACENT PROPERTY OWNERS:**

See JARPA

**PHOTOPLATE 2**

**APPLICANT:** Port of Kalama

**PROJECT NAME:** Port of Kalama T-Barge Dock

**REFERENCE #:** Not Yet Assigned

**SITE LOCATION ADDRESS:**

1296 Third St. NW  
Kalama, WA

**PROPOSED:** New Dock

**IN** Columbia River - RM 74.3

**NEAR:** Kalama

**COUNTY:** Cowlitz **STATE:** WA

**SHEET 7 OF 8**

**DATE:** 4/2/18



Photograph of T-barge. Framework above the deck has been removed.

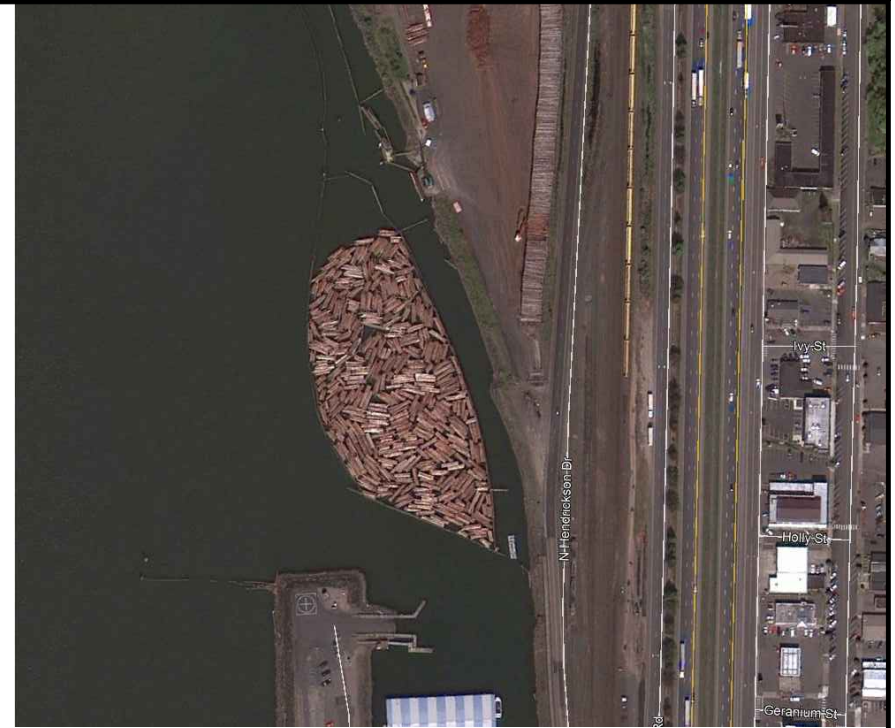

Photograph showing the extent of the log storage area.

NOT TO SCALE



1157 3rd Ave., Suite 220A  
 Longview, WA 98632  
 Phone: (360) 578-1371

**PURPOSE:**  
 Moor small vessels to  
 serve shipping industry  
**DATUM:** NAD83  
**ADJACENT PROPERTY OWNERS:**  
 See JARPA

**PHOTOPLATE 3**

**APPLICANT:** Port of Kalama  
**PROJECT NAME:** Port of Kalama T-Barge Dock  
**REFERENCE #:** Not Yet Assigned  
**SITE LOCATION ADDRESS:**  
 1296 Third St. NW  
 Kalama, WA

**PROPOSED:** New Dock  
**IN** Columbia River - RM 74.3  
**NEAR:** Kalama  
**COUNTY:** Cowlitz **STATE:** WA  
**SHEET 8 OF 8**  
**DATE:** 4/2/18